

## Specialist Building Products Limited

Pioneer House  
Mariner  
Lichfield Road Industrial Estate  
Tamworth  
Staffordshire B79 7TF

Tel: 01827 317200 Fax: 01827 317201

e-mail: [marketing@swishbp.co.uk](mailto:marketing@swishbp.co.uk)

website: [www.swishbp.co.uk](http://www.swishbp.co.uk)



**Agrement Certificate**

**91/2620**

Product Sheet 1

### SWISH ROOFLINE SYSTEM

### SWISH CELLULAR PVC-U ROOFLINE SYSTEM

This Agrément Certificate Product Sheet<sup>(1)</sup> relates to the Swish Cellular PVC-U Roofline System, comprising fascia, soffit and barge boards, soffit ventilator and accessories, for external use at the roofline as a substitute for timber or other conventional materials. The components of the system are available in white and are suitable for new or existing domestic and non-domestic buildings.

(1) Hereinafter referred to as 'Certificate'.

#### CERTIFICATION INCLUDES:

- factors relating to compliance with Building Regulations where applicable
- factors relating to additional non-regulatory information where applicable
- independently verified technical specification
- assessment criteria and technical investigations
- design considerations
- installation guidance
- regular surveillance of production
- formal three-yearly review.



#### KEY FACTORS ASSESSED

**Ventilation** — the ventilated soffit boards can contribute towards providing the necessary roof space ventilation (see section 6).

**Strength and stability** — in terms of wind loading resistance, the system can be used in all areas of the UK (see section 7).

**Performance in relation to fire** — the cellular boards achieve a Class 1 or Class 1Y surface spread of flame classification when tested in accordance with BS 476-7 : 1997 (see section 8).

**Durability** — the system will retain adequate impact resistance and its decorative function for a period in excess of 35 years with only minor changes in surface appearance (see section 10).



The BBA has awarded this Certificate to the company named above for the system described herein. This system has been assessed by the BBA as being fit for its intended use provided it is installed, used and maintained as set out in this Certificate.

On behalf of the British Board of Agrément

Date of Fourth issue: 28 May 2021

Originally certificated on 27 March 1991

Hardy Giesler  
Chief Executive Officer

The BBA is a UKAS accredited certification body – Number 113.

The schedule of the current scope of accreditation for product certification is available in pdf format via the UKAS link on the BBA website at [www.bbacerts.co.uk](http://www.bbacerts.co.uk)

Readers **MUST** check the validity and latest issue number of this Agrément Certificate by either referring to the BBA website or contacting the BBA directly.

Any photographs are for illustrative purposes only, do not constitute advice and should not be relied upon.

#### British Board of Agrément

Bucknalls Lane  
Watford  
Herts WD25 9BA

tel: 01923 665300  
[clientservices@bbacerts.co.uk](mailto:clientservices@bbacerts.co.uk)  
[www.bbacerts.co.uk](http://www.bbacerts.co.uk)

©2021

## Regulations

In the opinion of the BBA, Swish Cellular PVC-U Roofline System, if installed, used and maintained in accordance with this Certificate, can satisfy or contribute to satisfying the relevant requirements of the following Building Regulations (the presence of a UK map indicates that the subject is related to the Building Regulations in the region or regions of the UK depicted):



### The Building Regulations 2010 (England and Wales) (as amended)

<b>Requirement:</b>	<b>C2(b)</b>	<b>Resistance to moisture</b>
Comment:		The system will contribute to providing protection against the penetration of moisture to the inner surface of the building on which it is installed. See section 4.1 of this Certificate.
<b>Requirement:</b>	<b>C2(c)</b>	<b>Resistance to moisture</b>
Comment:		The soffit ventilators can contribute to enabling a roof to satisfy this Requirement. See sections 6.1 to 6.6 of this Certificate.
<b>Regulation:</b>	<b>7(1)</b>	<b>Materials and workmanship</b>
Comment:		The components of the system are acceptable. See section 10.1 and the <i>Installation</i> part of this Certificate.
<b>Regulation:</b>	<b>7(2)</b>	<b>Materials and workmanship</b>
Comment:		The system is restricted by this Regulation. See section 8.1 of this Certificate.



### The Building (Scotland) Regulations 2004 (as amended)

<b>Regulation:</b>	<b>8(1)(2)</b>	<b>Durability, workmanship and fitness of materials</b>
Comment:		The system is acceptable. See sections 9 and 10.1 and the <i>Installation</i> part of this Certificate.
<b>Regulation:</b>	<b>9</b>	<b>Building standards applicable to construction</b>
Standard:	<b>2.6</b>	Spread to neighbouring buildings
Comment:		The system is restricted by this Standard, with reference to clauses 2.6.5 <sup>(1)</sup> and 2.6.6 <sup>(2)</sup> . See section 8.1 of this Certificate.
Standard:	<b>3.10</b>	Precipitation
Comment:		The system will contribute to satisfying this Standard, with reference to clause 3.10.1 <sup>(1)(2)</sup> , by giving protection against the penetration of moisture to the inner surface of the building on which it is installed. See section 4.1 of this Certificate.
Standard:	<b>3.15</b>	Condensation
Comment:		The soffit ventilators can contribute to enabling a roof to satisfy this Standard, with reference to clauses 3.15.1 <sup>(1)(2)</sup> , 3.15.3 <sup>(1)(2)</sup> , 3.15.5 <sup>(1)(2)</sup> , 3.15.6 <sup>(1)(2)</sup> and 3.15.7 <sup>(1)(2)</sup> . See sections 6.1 to 6.6 of this Certificate.
<b>Regulation:</b>	<b>12</b>	<b>Building standards applicable to conversions</b>
Comment:		All comments given for this system under Regulation 9, Standards 1 to 6, also apply to this Regulation, with reference to clause 0.12.1 <sup>(1)(2)</sup> and Schedule 6 <sup>(1)(2)</sup> .

(1) Technical Handbook (Domestic).

(2) Technical Handbook (Non-Domestic).



### The Building Regulations (Northern Ireland) 2012 (as amended)

<b>Regulation:</b>	<b>23</b>	<b>Fitness of materials and workmanship</b>
Comment:		The system is acceptable. See section 10.1 and the <i>Installation</i> part of this Certificate.

<b>Regulation:</b>	<b>28(b)</b>	<b>Resistance to moisture and weather</b>
<b>Comment:</b>		The system will contribute to providing protection against the penetration of moisture to the inner surface of the building on which it is installed. See section 4.1 of this Certificate.
<b>Regulation:</b>	<b>29</b>	<b>Condensation</b>
<b>Comment:</b>		The soffit ventilators can contribute towards enabling a roof to satisfy the requirements of this Regulation. See sections 6.1 to 6.6 of this Certificate.

## Construction (Design and Management) Regulations 2015 Construction (Design and Management) Regulations (Northern Ireland) 2016

Information in this Certificate may assist the client, designer (including Principal Designer) and contractor (including Principal Contractor) to address their obligations under these Regulations.

See sections: 3 *Delivery and site handling* (3.2) and 12 *General* (12.3 and 12.7) of this Certificate.

### Additional Information

#### NHBC Standards 2021

In the opinion of the BBA, the Swish Cellular PVC-U Roofline System, if installed, used and maintained in accordance with this Certificate, can satisfy or contribute to satisfying the relevant requirements in relation to *NHBC Standards*, Chapters 7.1 *Flat roofs, terraces and balconies* and 7.2 *Pitched roofs*.

### Technical Specification

#### 1 Description

1.1 The Swish Cellular PVC-U Roofline System comprises a range of white cellular PVC-U (PVC-UE) soffit, fascia and barge boards and ancillary components including extruded trims, injection-moulded joints and end caps. The cellular boards comprise a closed-cell cellular PVC-U core beneath an outer weathering impact-modified PVC-U skin.

##### Fascia boards

1.2 The fascia boards are available in thicknesses of 9, 16, 20<sup>(1)</sup> and 25 mm<sup>(1)</sup> (see Table 1). The boards are extruded in standard 5 m lengths with a nominal density of 370 to 500 kg·m<sup>-3</sup> and a skin thickness of 0.3 mm.

(1) The 20 mm and 25 mm fascia boards are also called Jumbo boards.

**Table 1 Fascia boards**

Fascia board	Board thickness (mm)	Width (mm)	Fascia board	Board thickness (mm)	Width (mm)	Fascia board	Board thickness (mm)	Width (mm)
Cappit	9	150–605	Flat board	16	150–405	Standard Jumbo	20	150–455
Ogee cappit	12 (including ribs)	150–405	Bullnose fascia	16	150–455	Bullnose Jumbo	25	150–405
Ogee fascia	20	150–405	Square fascia	16	150–405	Ogee Jumbo	20	150–405

1.3 The ribs running along the unexposed face of the Ogee cappit boards are intended to allow air to the backing board and maintain a level front surface.

1.4 The 16 mm fascia board is also available with a decorative chamfered cut edge, either convex or concave (see Figure 1). The purpose of the chamfer is to reduce the visibility of the cut edge. The minimum width of the decorative board is 160 mm.

1.5 All fascia profiles are available as double-ended boards in widths of 355, 405 and 455 mm.



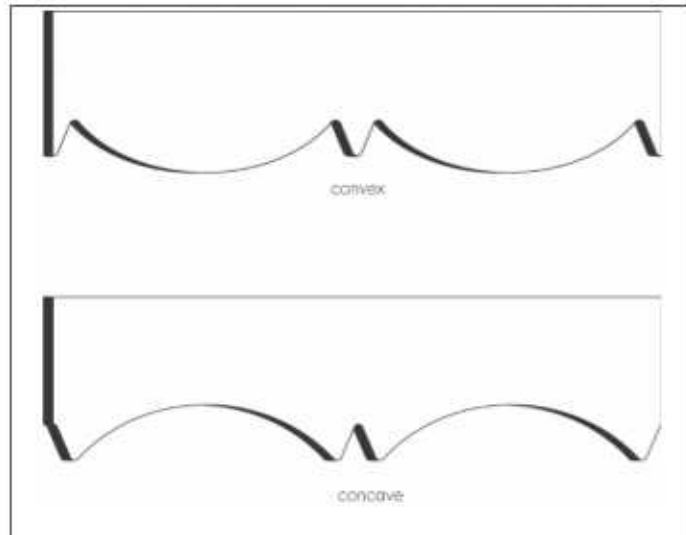

Figure 1 16 mm fascia board with decorative cut edge







### Soffit boards

1.6 Unvented (Table 2) and vented boards (for ventilating the roof void, Table 3) are available.

Table 2 Soffit boards (unvented)

Soffit board	Board thickness (mm)	Width (mm)
<b>Gee Pee boards</b>	9	100–605
		
<b>Fluted soffit</b>	9	300
		
<b>Cladding soffits</b>		
<b>Shiplap</b>	6 or 7	100 or 150
		
<b>Open 'V'</b>	7 or 7.5	100 or 150
		
<b>Tee Gee</b>	6	125
		

Soffit board	Board thickness (mm)	Width (mm)
<b>Polo board with a single row of vents</b>	9	100–605
		
<b>Polo board with a double row of vents</b>	9	150–450
		
<b>Tee Gee Polo cladding</b>	6	125
		
<b>Open 'V' Polo cladding</b>	7.5	150
		

1.7 All boards (Table 3) are available with a single row of slots, suitable for providing ventilation to satisfy the requirement for a ventilation area which has a continuous air gap at least 10 mm wide at the eaves. The Polo boards are also available with a double row of slots, providing a ventilation area which has a continuous air gap at least 25 mm wide at the eaves.

1.8 Board thicknesses and widths are given in Tables 2 and 3.

#### Trims and ancillaries

1.9 A range of impact-modified PVC-U extruded trims is available, with typical examples shown in Figure 2. Joint covers are available for use with the cellular boards.

1.10 Ancillary items specified by the Certificate holder for use with the system but outside the scope of this Certificate include:

- stainless steel nails — a range of stainless steel<sup>(1)</sup> annular ring shank nails with white plastic heads with white cover caps, for fixing the boards to sound roof timbers

(1) A4 (steel No 1.4401 to BS EN 10088-2 : 2014).

- silicone sealant — low modulus, for fixing cover trims to boards at corners and abutments.

Figure 2 Trims

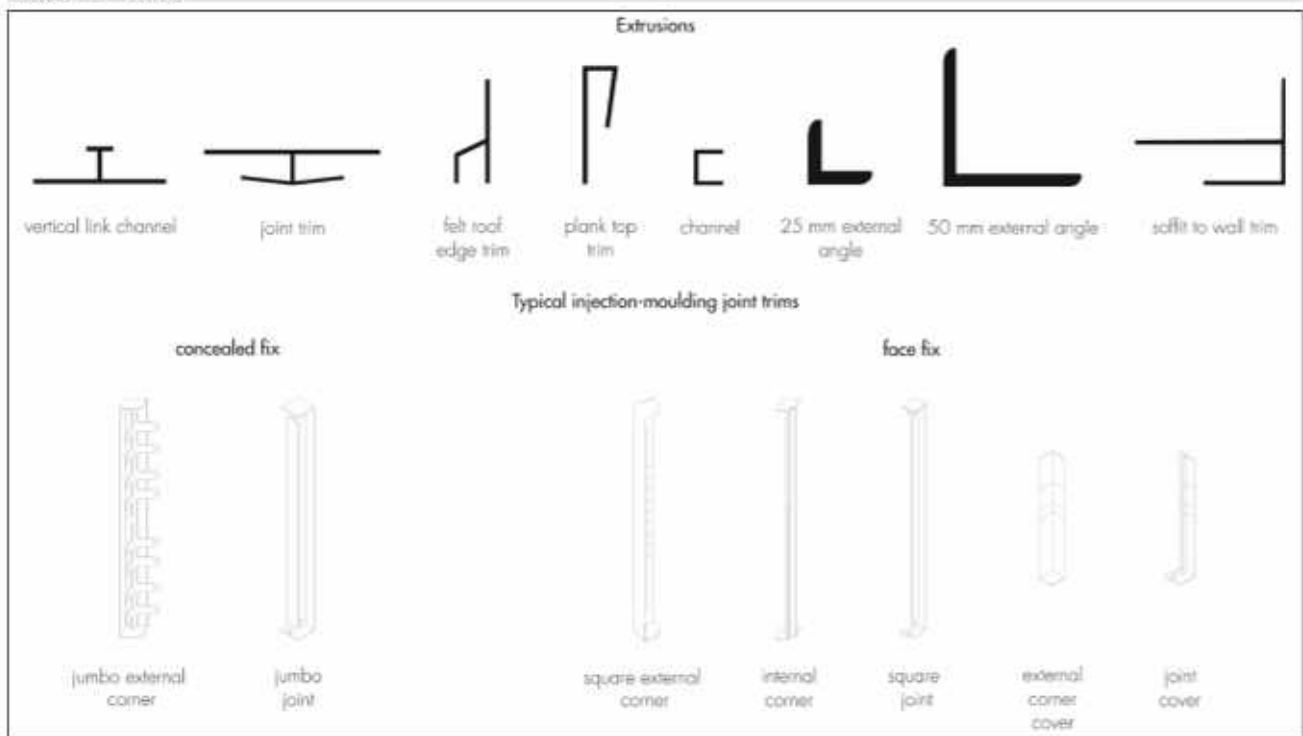

## 2 Manufacture

2.1 Cellular PVC-U is formed by the evolution of gas from sodium bicarbonate present in the foamable PVC-U compound. The PVC-UE boards are manufactured by co-extruding the skin compound onto a foamable core compound, and cooling and forming to section. Both core and skin formulations include a tin-based stabiliser. Polo ventilated soffit boards are produced by punching 4 by 35 mm slots into Gee Pee, Tee Gee cladding or Open 'V' cladding soffit boards at regular intervals. A transparent polythene film is applied to the outer face of the extrusion before the board is cut to length.

2.2 The trims are extruded from rigid PVC-U using conventional extrusion techniques. Joint covers are manufactured from acrylate styrene acrylonitrile (ASA) using conventional injection-moulding techniques.

2.3 As part of the assessment and ongoing surveillance of product quality, the BBA has:

- agreed with the manufacturer the quality control procedures and product testing to be undertaken
- assessed and agreed the quality control operated over batches of incoming materials
- monitored the production process and verified that it is in accordance with the documented process
- evaluated the process for management of nonconformities
- checked that equipment has been properly tested and calibrated
- undertaken to carry out the above measures on a regular basis through a surveillance process, to verify that the specifications and quality control operated by the manufacturer are being maintained.

2.4 The management system of Specialist Building Products Limited has been assessed and registered as meeting the requirements of BS EN ISO 9001 : 2015 (Certificate FS 681825) and BS EN ISO 14001 : 2015 (Certificate EMS 681826) by BSI.

## 3 Delivery and site handling

3.1 Standard 5 m lengths of boards and rigid extruded trims are delivered to site in packs sealed in polythene sleeves bearing the Certificate holder's marking and the BBA logo incorporating the number of this Certificate. Pack quantities vary dependent upon the type of profile. Mouldings (fascia joints and corners) are generally supplied in bags (with two or ten pieces) and boxes.

3.2 The packs should be unloaded by hand to avoid damage, and stored flat on a clean, level surface in their protective wrapping. Stacks must not exceed one metre in height, and must be restrained to prevent collapse. If stored externally, the packs should be kept under cover, away from direct sunlight.

3.3 Care must be taken when handling PVC-U boards and trims to avoid contact with solvents or materials containing volatile organic components.

## Assessment and Technical Investigations

The following is a summary of the assessment and technical investigations carried out on the Swish Cellular PVC-U Roofline System.

## Design Considerations

### 4 Use



4.1 The Swish Cellular PVC-U Roofline System is suitable for use externally to provide a protective and decorative trim at the roofline as fascia, soffit and barge boards where timber or other conventional materials would normally be used. The system will contribute to providing protection against the penetration of moisture to the inner surface of the building.

4.2 The soffit ventilation products provide a means of ventilating the roof void.

4.3 The system must be fixed only to structurally sound building substrates, at centres not exceeding 600 mm. Rafter feet and gable ladders should be adequately supported by noggings to ensure rigidity. Replacement, rather than over fixing of existing fascia, is recommended. Timber roof structures to which the system is fixed, must be designed and/or constructed in accordance with the relevant national Building Regulations and BS EN 1995-1-1 : 2004 and its UK National Annex.

4.4 The system components have a similar coefficient of thermal expansion to that of conventional solid PVC-U. An 8 mm gap should be provided between abutting fascia and soffit boards, to allow for movement. Care should be taken not to install the system in extremes of temperature. The recommended temperature for installation is between 5 and 25°C.

### 5 Practicability of installation

The system is designed to be installed by a competent general builder, or a contractor, experienced with this type of system.

### 6 Ventilation



6.1 The Swish Polo ventilated soffit boards can contribute towards providing the necessary roof space ventilation (see Table 4). Guidance on the provision of adequate ventilation is given in the documents supporting the national Building Regulations and BS 5250 : 2011, Annex H. Designers should take regard of roof size and complexity and air permeability of roof coverings when determining the location and size of ventilation openings.

Table 4 Ventilation products' open area

Product name	Open area (mm <sup>2</sup> per metre run)	Width of a continuous slot with the same area <sup>(1)</sup> (mm)
Ventilated soffit boards with a double row of slots	25 946	25.9
Ventilated soffit boards with a single row of slots	12 973	13

(1) At eaves level.



### **Cold flat roofs**

6.2 The ventilated soffit boards with a double row of slots are suitable. For roof spans up to 5 m, reference may be made to BRE Report BR 262 : 2002.

### **Cold pitched roofs >10° and <75° with an LR type underlay**

6.3 The ventilated soffit boards with a single row of slots are suitable.

### **Cold pitched roofs >15° and <75° with an HR type underlay**

6.4 The ventilated soffit boards with a single row of slots are suitable. For pitches exceeding 35°, spans exceeding 10 m or lean-to or monopitch roofs, additional high level ventilation will also be required.

### **Warm pitched roofs**

6.5 The ventilated soffit boards with a double row of slots are suitable. For lean-to or monopitch roofs, additional high level ventilation will also be required.

### **Hybrid pitched roofs**

6.6 The ventilated soffit boards with a double row of slots are suitable. Additional ventilation openings should be provided either side of any interruptions such as dormers, rooflights, etc, and at high level.

6.7 When providing roof space ventilation, it is essential that the airway should not be allowed to become blocked by the loft insulation. This may be achieved by the use of a suitable insulation retainer producing an air passage with a geometric free area at least equal to that of the ventilated soffit ventilator used.

## **7 Strength and stability**

7.1 When installed in accordance with this Certificate and taking into account the site-specific circumstances, the system will withstand, without damage or permanent deflection, the wind loads likely to be encountered in the UK. In exposed locations, care should be taken to ensure that all profiles are adequately fixed.

7.2 The system has adequate resistance to the hard and soft body impacts likely to occur in practice.

7.3 PVC-U gutters, as specified in BS EN 607 : 2004, may be screw-fixed directly to the 16 mm and Jumbo fascia boards. Gutter bracket spacings must not exceed one metre; reduced spacings are recommended in areas of high exposure, eg the Scottish Highlands, and the advice of a suitably experienced and competent individual sought. Other lightweight gutters may also be screw-fixed to the board provided the maximum bracket-loading, covered in BS EN 1462 : 2004, is not exceeded. For all other boards, all gutters should be fixed through the fascia to rafter ends or sound timber.

7.4 The 16 mm and Jumbo fascia boards will support all eaves tiles in common usage in the UK (up to 10 kg load per 1 m length of fascia), provided they are installed in accordance with the requirements of this Certificate.

7.5 Alongside the exceptions detailed in section 7.4, the fascia boards are not loadbearing and must not be used independently to support fixtures such as roof tiles, gutters, other roof structure components or television aerials. Suitably fixed telephone wires and power cables may be run along the boards but the main brackets for these services should be fixed through the fascia to structurally sound timber.

## **8 Performance in relation to fire**



8.1 Selected cellular boards achieved the fire classifications to BS 476-7 : 1997 shown in Table 5. The performance of the other products has not been classified.

**Table 5 Roofline boards – classifications to BS 476-7 : 1997**

Board	Board thickness (mm)	Classification	Test report reference <sup>(1)</sup>
GeePee Soffit board	9	Class 1Y	Exova 197236, 8 October 2010
C354W 405 Fascia screwed to timber frame	16	Class 1Y	Exova 370164, 5 September 2016
Square fascia	16	Class 1	Exova 197683, 12 October 2010
Jumbo	20	Class 1	Exova 197238, 8 October 2010

(1) Test reports are available from the Certificate holder.

8.2 Where it is normal practice to carry the eaves box over, between dwellings, it is important that the box is fire stopped at compartment walls.

## 9 Maintenance



9.1 The system can be cleaned by washing with water and mild detergent. Abrasive or solvent-based cleaners must not be used. For the removal of more resistant stains, the Certificate holder's advice must be sought. If repairs are required, the material can be cut and drilled, using normal woodworking tools.

9.2 The dimensions of the slots in the ventilation products are such that the risk of blockage is limited. However, blockage by insects and debris would impair their performance as vents and the slots should be examined periodically and cleared if necessary.

## 10 Durability



10.1 Swish Cellular PVC-U is as durable as conventional solid PVC-U and the boards will retain adequate impact resistance for a period in excess of 35 years.

10.2 The system will retain its decorative function for the service life of the product with only minor changes in surface appearance.

10.3 Paint must not be applied as, with all PVC products, it can adversely affect the impact strength of the cellular PVC-U sections.

10.4 Where the timber substrate is preservative treated, care must be taken to ensure that sufficient time is allowed for complete fixation of the preservative to avoid corrosion of screws and nails used to fix the components.

## 11 Reuse and recyclability

The PVC-U and PVC-UE profile materials can be recycled.

## Installation

### 12 General

12.1 Installation of the Swish Cellular PVC-U Roofline System must be carried out in accordance with the Certificate holder's instructions and the requirements of this Certificate (see Figure 3).

Figure 3 Typical installation details

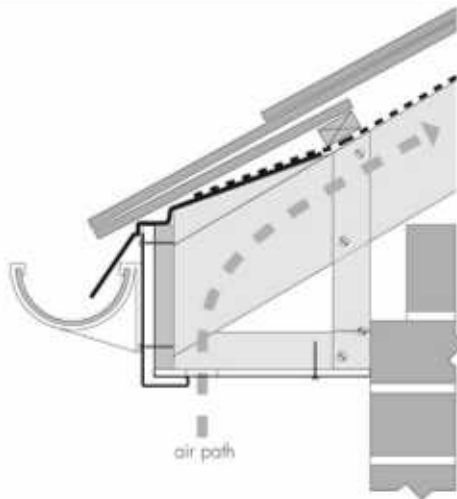

9 mm Cappit fascia with Polo board soffit

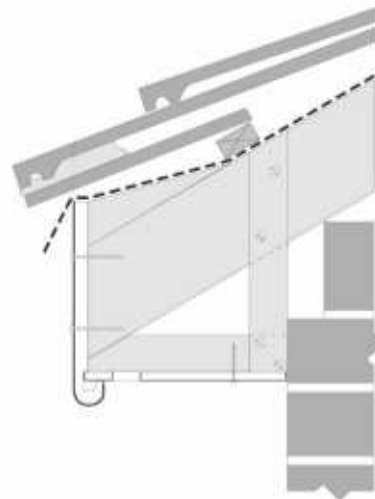

16 mm Bullnose fascia with Gee Pee board soffit

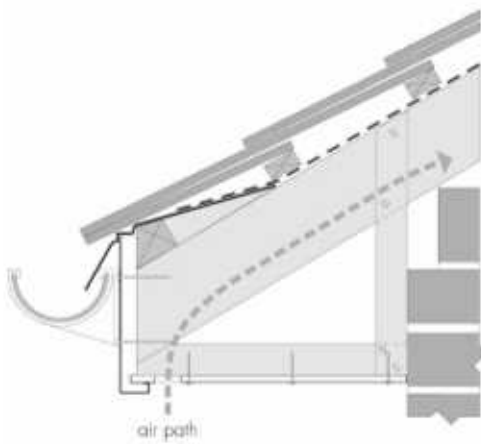

Standard Jumbo with Polo board soffit

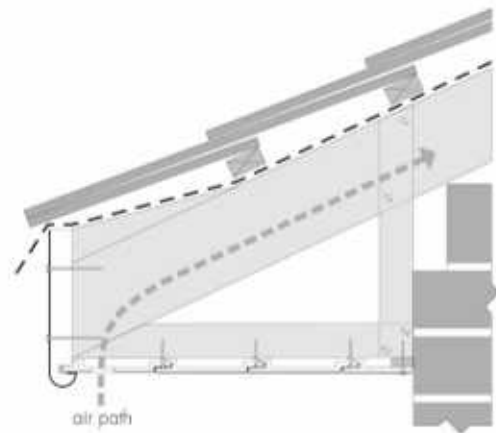

Bullnose jumbo with Tee Gee Polo cladding soffit

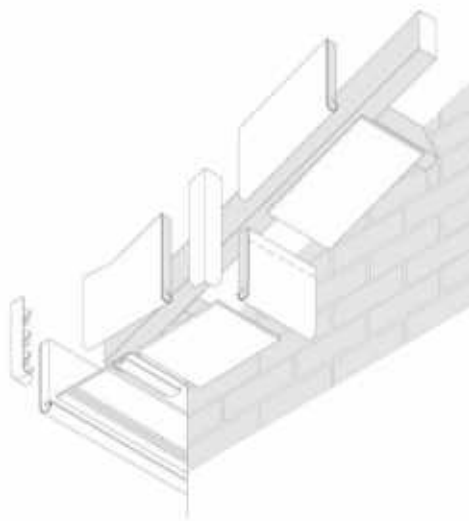

Box end detail (cut fascia board)

Figure 3 Typical installation details (continued)

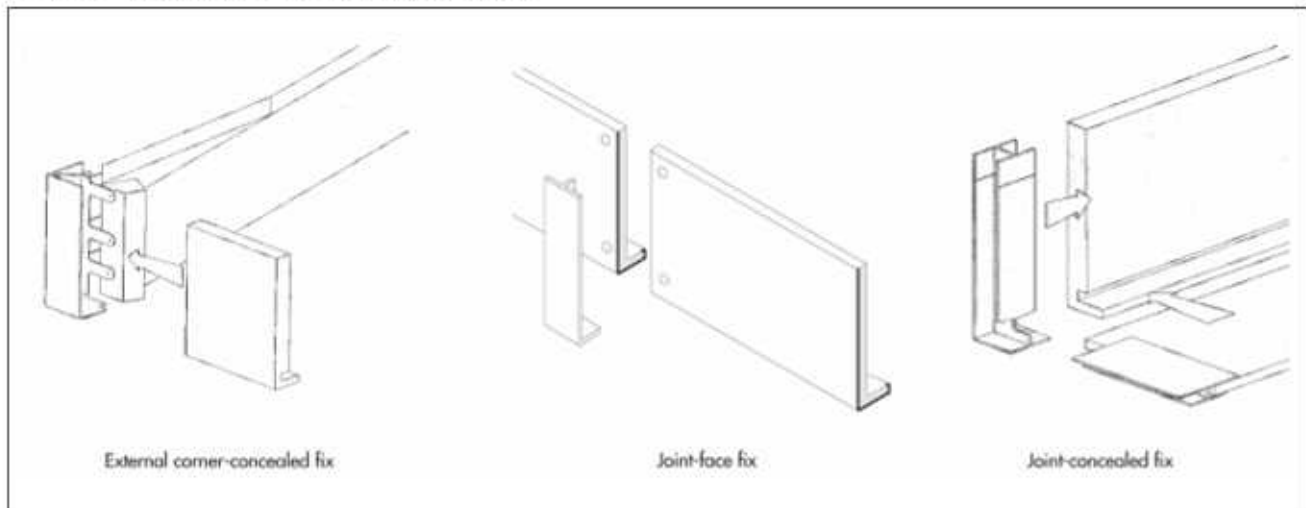

12.2 The components of the system are worked using normal woodworking tools for cutting, drilling and shaping. Handsaws should have a fine-toothed blade. Hand-held and bench-mounted power tools with a carbide-tipped blade should be run at speeds similar to, or higher than, those normally used for timber.

12.3 When using power tools to cut or shape the components, eye protection and a coarse particle dust mask must be used.

12.4 Fascia, soffit and barge boards should be fixed to preservative-treated, structurally sound, solid timbers at centres not exceeding 600 mm, using the fixings specified by the Certificate holder.

12.5 Existing support timbers should be checked for soundness and, where necessary, replaced. Existing fascia board should not be used as a support/backing board for a cover board.

12.6 The sarking felt should be checked, to ensure that it is in a good condition and extends onto the verge rafter and over the fascia and into the gutter at the eaves. A continuous fillet or eaves protection system should be installed at the eaves to prevent the felt sagging between the rafters. Damaged or worn felt should be replaced in accordance with good practice.

12.7 Normal precautions should be taken when working at roof level. The use of protective goggles when cutting and nailing is recommended.

12.8 Ventilated boards should be selected and installed so that the roof ventilation conforms to the relevant national Building Regulations.

12.9 It is recommended that the 9 mm fascia boards are fixed over a sound backing board. This may be an existing fascia providing it is inspected thoroughly and found to be in a sound condition. Otherwise, the existing fascias should be removed and replaced by minimum 12 mm thick marine grade plywood or other equivalent backing board.

12.10 A minimum of two 50 mm nails or two 40 mm screws per maximum 600 mm centres are used for fixing 9 mm fascias.

12.11 The 16 mm and Jumbo fascia boards may be used directly to support PVC-U and other lightweight gutters (see section 7.3).

12.12 The 16 mm and Jumbo fascia boards may be used to support eaves tiles (see section 7.4). In certain geographical/topographical locations, the eaves tiles will need to be restrained in order to resist wind uplift. Guidance on this fixing should be sought from the manufacturer of the eaves tiles.

12.13 A minimum of two 65 mm nails<sup>(1)</sup> at maximum 600 mm centres are used for fixing 16 mm and Jumbo fascia boards to rafter feet.

(1) Outside the scope of this Certificate.

## 13 Procedure

13.1 Selected boards and accessories are assembled and cut to size.

13.2 Rafter feet are cut to a line.

13.3 Noggings, soffit bearers, battens, eaves fillets, brackets and other additional timber supports are fixed to a sound substrate.

13.4 Protective films should be removed prior to fixing, by peeling off as nailing progresses along the board.

13.5 The summary for the installation details of fascia, soffit and barge boards (see sections 13.6 to 13.16) should be read with reference to the typical installation diagrams shown in Figure 3.

### Fascia boards

13.6 Fascia boards are fixed to rafter feet or, where relevant, to support timber at centres not exceeding 600 mm using at least two fixings<sup>(1)</sup> per rafter. When the product is installed in particularly exposed locations, it is recommended that the fascia boards are fixed to support timbers at maximum 400 mm centres.

(1) Outside the scope of this Certificate.

13.7 Where necessary, fascia boards are joined between rafters using the appropriate joint trim cut to size. The trim is fixed to one board only, allowing a 4 mm gap for expansion at the end of each board. Depending on the particular trim, either a low modulus silicone sealant or a nail through the spine of the trim into the end of the board is used, to secure the trim in place.

13.8 At external corners, the appropriate corner joint trim, cut to size, is used. The trim is either nailed to timber work through the holes provided in the inner lug of the trim using the specified 25 mm nail<sup>(1)</sup> or face-fixed to one board with a low-modulus silicone sealant<sup>(1)</sup>, depending on the particular trim. In each case, a 4 mm gap for expansion is left at the end of each board.

(1) Outside the scope of this Certificate.

13.9 Internal corner joint trims are available for some boards, which are fitted by the procedure described in section 13.8 for external corners.

13.10 Gutter brackets are fixed through the 9 mm fascia into supporting timberwork, normally the rafter feet. Gutter brackets are fixed directly to the 16, 20 and 25 mm fascia boards.

(1) Outside the scope of this Certificate.

### Soffit boards

13.11 Soffit boards, fitted into or butted up against fascia boards, may be used in a variety of ways, as illustrated in Figure 3.

13.12 Soffit boards should be fixed into soffit bearers, battens secured to the wall, or the underside of the rafters at maximum 600 mm centres along their length, and 200 mm centres across their width, using 40 mm nails<sup>(1)</sup> specified by the Certificate holder.

13.13 Where cladding boards are used to construct a soffit, the instructions specified for this product should be followed, starting at the fascia and working towards the building using the specified secret-fix annular ring-shank nails<sup>(1)</sup>.

(1) Outside the scope of this Certificate.

13.14 For soffit runs in excess of 5 m, board ends are fitted into a soffit joint trim.

13.15 Soffit corner returns are made by cutting the boards to the appropriate angle and joining with a soffit joint trim.

13.16 To comply with the requirements of the documents supporting the national Building Regulations, soffit ventilated boards should be used as required.

(1) Outside the scope of this Certificate.

### **Barge boards**

13.17 Barge boards are installed by fixing fascia boards to a gable ladder or noggings, using the procedure given for fascia boards.

13.18 The ridge joint should be made using an appropriate joint trim, depending on the barge board profile.

13.19 Eaves box ends are constructed using the appropriate fascia board and cut to suit the roof pitch, fascia and soffit detail. The fascia boards are nailed<sup>(1)</sup> to the roof timbers and the box end trims fixed to the PVC-UE boards, with low modulus silicone sealant<sup>(1)</sup> and, if necessary, additional nail trims. Any timber framework required in the construction of the box end must be preservative-treated.

(1) Outside the scope of this Certificate.

13.20 Treated timber should be used to create the support framework required for the box end.

## **Technical Investigations**

### **14 Tests**

Tests were carried out on the cellular boards and trims to determine:

- thickness of layers
- weight per linear metre
- IZOD impact strength
- dimensional stability
- nail pull-through
- Vicat softening point
- ash content
- impact resistance
- tensile strength/elongation
- heat reversion
- density
- tensile impact strength
- stress relief
- modulus of elasticity
- acetone resistance
- impact strength/dehydrochlorination (DHC)/appearance after UV ageing
- impact strength/DHC/appearance after heat ageing
- impact strength/DHC/appearance after water soak ageing
- resistance to tile and gutter loading.

### **15 Investigations**

15.1 The dimensions of the cellular boards and trims were checked.

15.2 An examination was made of existing data relating to:

- reaction to fire performance
- colour stability
- impact strength before and after UV ageing.

15.3 The manufacturing process, including the methods adopted for quality control, was assessed and details were obtained of the quality and composition of the materials used.

15.4 The practicability of installation was assessed.

15.5 An assessment was made of the resistance of the products to wind suction.

15.6 An assessment was made of the acceptability of soffit ventilators in satisfying ventilation requirements.

## Bibliography

BRE Report BR 262 : 2002 *Thermal insulation: avoiding risks*

BS 476-7 : 1997 *Fire tests on building materials and structures — Method of test to determine the classification of the surface spread of flame of products*

BS 5250 : 2011 + A1 : 2016 *Code of practice for control of condensation in buildings*

BS EN 607 : 2004 *Eaves gutters and fittings made of PVC-U — Definitions, requirements and testing*

BS EN 1462 : 2004 *Brackets for eaves gutters — Requirements and testing*

BS EN 1995-1-1 : 2004 + A2 : 2014 *Eurocode 5 : Design of timber structures — General — Common rules and rules for buildings*

NA to BS EN 1995-1-1 : 2004 + A1 : 2008 *UK National Annex to Eurocode 5-Design of timber structures General — Common rules and rules for buildings*

BS EN 10088-2 : 2014 *Stainless steels — Technical delivery conditions for sheet/plate and strip of corrosion resisting steels for general purposes*

BS EN ISO 9001 : 2015 *Quality management systems — Requirements*

BS EN ISO 14001 : 2015 *Environmental management systems — Requirements with guidance for use*

### 16 Conditions

16.1 This Certificate:

- relates only to the product/system that is named and described on the front page
- is issued only to the company, firm, organisation or person named on the front page – no other company, firm, organisation or person may hold or claim that this Certificate has been issued to them
- is valid only within the UK
- has to be read, considered and used as a whole document – it may be misleading and will be incomplete to be selective
- is copyright of the BBA
- is subject to English Law.

16.2 Publications, documents, specifications, legislation, regulations, standards and the like referenced in this Certificate are those that were current and/or deemed relevant by the BBA at the date of issue or reissue of this Certificate.

16.3 This Certificate will remain valid for an unlimited period provided that the product/system and its manufacture and/or fabrication, including all related and relevant parts and processes thereof:

- are maintained at or above the levels which have been assessed and found to be satisfactory by the BBA
- continue to be checked as and when deemed appropriate by the BBA under arrangements that it will determine
- are reviewed by the BBA as and when it considers appropriate.

16.4 The BBA has used due skill, care and diligence in preparing this Certificate, but no warranty is provided.

16.5 In issuing this Certificate the BBA is not responsible and is excluded from any liability to any company, firm, organisation or person, for any matters arising directly or indirectly from:

- the presence or absence of any patent, intellectual property or similar rights subsisting in the product/system or any other product/system
- the right of the Certificate holder to manufacture, supply, install, maintain or market the product/system
- actual installations of the product/system, including their nature, design, methods, performance, workmanship and maintenance
- any works and constructions in which the product/system is installed, including their nature, design, methods, performance, workmanship and maintenance
- any loss or damage, including personal injury, howsoever caused by the product/system, including its manufacture, supply, installation, use, maintenance and removal
- any claims by the manufacturer relating to CE marking.

16.6 Any information relating to the manufacture, supply, installation, use, maintenance and removal of this product/system which is contained or referred to in this Certificate is the minimum required to be met when the product/system is manufactured, supplied, installed, used, maintained and removed. It does not purport in any way to restate the requirements of the Health and Safety at Work etc. Act 1974, or of any other statutory, common law or other duty which may exist at the date of issue or reissue of this Certificate; nor is conformity with such information to be taken as satisfying the requirements of the 1974 Act or of any statutory, common law or other duty of care.